

User Manual

ANNKE

Thank you very much for choosing ANNKE.

Our products are supported by the world's first video monitoring manufacturers,
and they have adopted military level of protection.

It is our top priority to ensure your data safety and offer you a satisfactory service.

We strongly recommend that you set up an appropriate password for your device and save it,
also set up security questions and reserved email to ensure you can reset password by yourself.

If you have any questions, please feel free to email us at **support@annke.com**.

Or visit our help center: **help.annke.com**.

Please download ANNKE App, Client software and user manuals from our download center:

<https://www.annke.com/pages/download-center>

About this Manual

The Manual includes instructions for using and managing the product. Pictures, charts, images and all other information hereinafter are for description and explanation only. The information contained in the Manual is subject to change, without notice, due to firmware updates or other reasons. Please find the latest version in the company website . Please use this user manual under the guidance of professionals.

Legal Disclaimer

REGARDING TO THE PRODUCT WITH INTERNET ACCESS, THE USE OF PRODUCT SHALL BE WHOLLY AT YOUR OWN RISKS. OUR COMPANY SHALL NOT TAKE ANY RESPONSIBILITIES FOR ABNORMAL OPERATION, PRIVACY LEAKAGE OR OTHER DAMAGES RESULTING FROM CYBER ATTACK, HACKER ATTACK, VIRUS INSPECTION, OR OTHER INTERNET SECURITY RISKS; HOWEVER, OUR COMPANY WILL PROVIDE TIMELY TECHNICAL SUPPORT IF REQUIRED.

SURVEILLANCE LAWS VARY BY JURISDICTION. PLEASE CHECK ALL RELEVANT LAWS IN YOUR JURISDICTION BEFORE USING THIS PRODUCT IN ORDER TO ENSURE THAT YOUR USE CONFORMS THE APPLICABLE LAW. OUR COMPANY SHALL NOT BE LIABLE IN THE EVENT THAT THIS PRODUCT IS USED WITH ILLEGITIMATE PURPOSES.

IN THE EVENT OF ANY CONFLICTS BETWEEN THIS MANUAL AND THE APPLICABLE LAW, THE LATER PREVAILS.

Regulatory Information

FCC Information

Please take attention that changes or modification not expressly approved by the party responsible for compliance could void the user's authority to operate the equipment.

FCC compliance: This equipment has been tested and found to comply with the limits for a Class B digital device, pursuant to part 15 of the FCC Rules. These limits are designed to provide reasonable protection against harmful interference in a residential installation. This equipment generates, uses and can radiate radio frequency energy and, if not installed and used in accordance with the instructions, may cause harmful interference to radio communications. However, there is no guarantee that interference will not occur in a particular installation. If this equipment does cause harmful interference to radio or television reception, which can be determined by turning the equipment off and on, the user is encouraged to try to correct the interference by one or more of the following measures:

—Reorient or relocate the receiving antenna.

- Increase the separation between the equipment and receiver.
- Connect the equipment into an outlet on a circuit different from that to which the receiver is connected.
- Consult the dealer or an experienced radio/TV technician for help.

FCC Conditions

This device complies with part 15 of the FCC Rules. Operation is subject to the following two conditions:

1. This device may not cause harmful interference.
2. This device must accept any interference received, including interference that may cause undesired operation.

EU Conformity Statement



This product and - if applicable - the supplied accessories too are marked with "CE" and comply therefore with the applicable harmonized European standards listed under the Low Voltage Directive 2015/35/EU, the EMC Directive 2014/30/EU, the RoHS Directive 2011/65/EU.



2012/19/EU (WEEE directive): Products marked with this symbol cannot be disposed of as unsorted municipal waste in the European Union. For proper recycling, return this product to your local supplier upon the purchase of equivalent new equipment, or dispose of it at designated collection points. For more information, please see: www.recyclethis.info.



2006/66/EC (battery directive): This product contains a battery that cannot be disposed of as unsorted municipal waste in the European Union. See the product documentation for specific battery information. The battery is marked with this symbol, which may include lettering to indicate cadmium (Cd), lead (Pb), or mercury (Hg). For proper recycling, return the battery to your supplier or to a designated collection point. For more information, please see: www.recyclethis.info.

Safety Instruction

These instructions are intended to ensure that user can use the product correctly to avoid danger or property loss. The precaution measure is divided into "Warnings" and "Cautions"

Warnings: Serious injury or death may occur if any of the warnings are neglected.

Cautions: Injury or equipment damage may occur if any of the cautions are neglected.

	
Warnings: Follow these safeguards to prevent serious injury or death.	Cautions: Follow these precautions to prevent potential injury or material damage.



Warnings

- Proper configuration of all passwords and other security settings is the responsibility of the installer and/or end-user.
- In the use of the product, you must be in strict compliance with the electrical safety regulations of the nation and region. Please refer to technical specifications for detailed information.
- Input voltage should meet both the SELV (Safety Extra Low Voltage) and the Limited Power Source with 100~240 VAC or 12 VDC according to the IEC60950-1 standard. Please refer to technical specifications for detailed information.
- Do not connect several devices to one power adapter as adapter overload may cause over-heating or a fire hazard.
- Please make sure that the plug is firmly connected to the power socket.
- If smoke, odor or noise rise from the device, turn off the power at once and unplug the power cable, and then please contact the service center.



Cautions

- Make sure the power supply voltage is correct before using the camera.
- Do not drop the camera or subject it to physical shock,
- Do not touch sensor modules with fingers. If cleaning is necessary, use clean cloth with a bit of ethanol and wipe it gently. If the camera will not be used for an extended period, replace the lens cap to protect the sensor from dirt.
- Do not aim the camera at the sun or extra bright places. Blooming or smearing may occur otherwise (which is not a malfunction), and affect the endurance of sensor at the same time.
- The sensor may be burned out by a laser beam, so when any laser equipment is in using, make sure that the surface of sensor will not be exposed to the laser beam.

- Do not place the camera in extremely hot, cold (the operating temperature shall be -30°C to +60°C, or -40°C to +60°C if the camera model has an "H" in its suffix) , dusty or damp locations, and do not expose it to high electromagnetic radiation.
- To avoid heat accumulation, good ventilation is required for operating environment.
- Keep the camera away from liquid while in use.
- While in delivery, the camera shall be packed in its original packing, or packing of the same texture.
- Regular part replacement: a few parts (e.g. electrolytic capacitor) of the equipment shall be replaced regularly according to their average enduring time. The average time varies because of differences between operating environment and using history, so regular checking is recommended for all the users. Please contact with your dealer for more details.
- Improper use or replacement of the battery may result in hazard of explosion. Replace with the same or equivalent type only. Dispose of used batteries according to the instructions provided by the battery manufacturer.
- If the product does not work properly, please contact your dealer or the nearest service center. Never attempt to disassemble the camera yourself. (We shall not assume any responsibility for problems caused by unauthorized repair or maintenance.)

1. Appearance Description

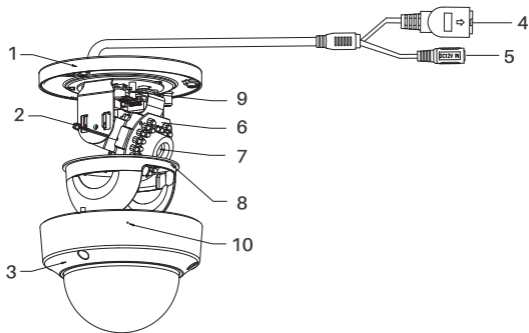

Camera Overview

No	Description	No	Description
1	Mounting Base	6	IR LED
2	Tilt Adjusting Screw	7	Lens
3	Bubble	8	Black Liner
4	Network Interface	9	Memory Card Slot
5	Power Interface	10	Mic

Note: Power on the camera when pressing the RESET button, and press button for another 10 seconds to restore the default settings, including the user name, password, IP address, port No, etc.

2. Installation

Before you start:

- Make sure the device in the package is in good condition and all the assembly parts are included.
- The standard power supply is 12 V DC or 24 V AC. Make sure your power supply matches with your camera.
- Make sure all the related equipment is power-off during the installation.
- Check the specification of the products for the installation environment.
- Make sure that the wall is strong enough to withstand four times the weight of the camera and the bracket. For the camera that supports IR, you are required to pay attention to the following precautions to prevent IR reflection:
 - Dust or grease on the dome cover will cause IR reflection. Do not remove the dome cover film until the installation is finished. If there is dust or grease on the dome cover, clean the dome cover with clean soft cloth and isopropyl alcohol.
 - Make sure that there is no reflective surface too close to the camera lens. The IR light from the camera may reflect back into the lens to cause the reflection.
 - The foam ring around the lens must be seated flush against the inner surface of the bubble to isolate the lens from the IR LEDs. Fasten the dome cover to camera body so that the foam ring and the dome cover are attached seamlessly.

2.1 Memory Card Installation

Steps:

1. Loosen the screws to remove the memory card slot cover.

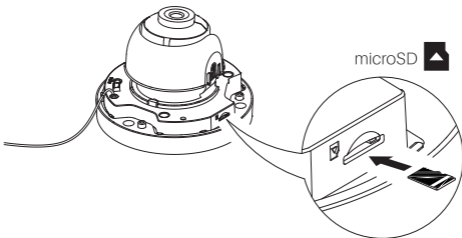

Unscrew the Cover and Insert Memory Card

3. Insert the memory card into the memory card slot.
4. (Optional) To unmount the memory card, push to get it ejected.
5. Screw the cover back to the camera.

2.2 Ceiling Mounting

Steps:

1. Attach the dill template to the ceiling.
2. Drill the screw holes and cable hole (optional) in the ceiling according to the drill template.

Note: Cable hole is required when you adopt ceiling outlet to route the cables.

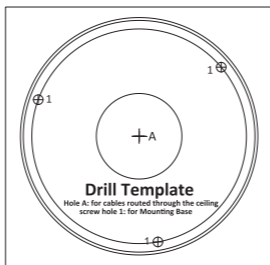

Drill Template

3. Loosen the set screws with a hex wrench (supplied) to remove the bubble

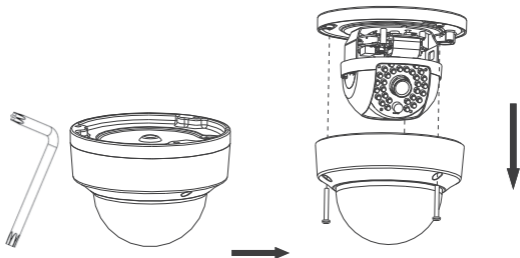

Remove the Bubble

4. Fix the mounting base on the ceiling with supplied screws.

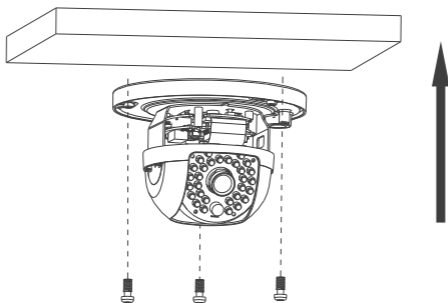

Fix the Mounting Base

5. Route the cables through the cable hole.

Note: If required, you can route cables through the side opening on the side of the mounting base.

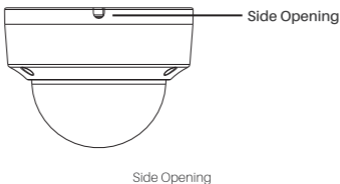

6. Connect the corresponding cables, such as power cable and network cable.

7. Power on the camera to check whether the image on the monitor is gotten from the optimum angle. If not, adjust the camera to get an optimum angle.

Notes:

- 5MP Camera supports 2-axis adjustment. Loosen the tilt adjusting screw to adjust the tilt angle [0° to 70°], hold the black liner to adjust the pan angle [0° to 355°]. See the figure below.

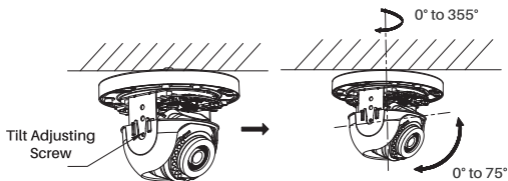

Camera 2-Axis Adjustment

- 4K camera supports 3-axis adjustment. Loosen the tilt adjusting screw to adjust the tilt angle [0° to 75°], hold the black liner to adjust the pan angle [0° to 355°], and hold the lens to rotate the camera [0° to 3550]. See the figure below.

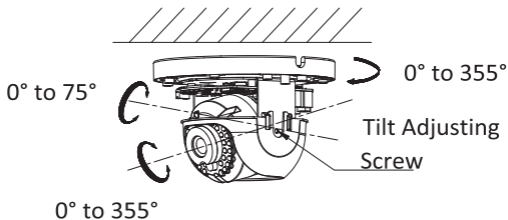

Camera 3-Axis Adjustment

8. Reinstall the bubble, and tighten the screws.

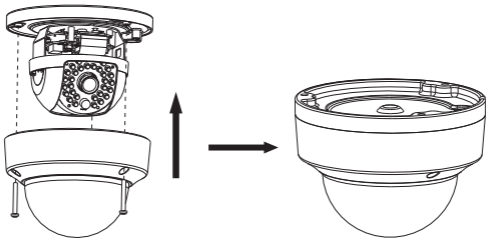

Bubble Reinstallation

3. Operate IP Cameras via IE Browser

You can configure the IP cameras in the LAN network via the IE browser.

1. Power on the camera with a DC 12 V adapter and connect it to the same router as your computer with a network cable.
2. Install the SADP software and search the camera.

You can download SADP software from our website: <https://www.annke.com/pages/download-center>.

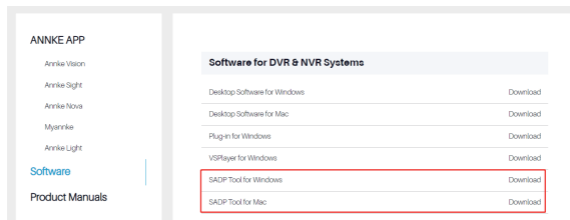

The screenshot shows the ANNKE APP website interface. On the left, there is a navigation menu with 'ANNKE APP' at the top, followed by 'Annikie Vision', 'Annikie Sight', 'Annikie Nova', 'Myannke', and 'Annikie Light'. Below these are 'Software' and 'Product Manuals'. The main content area is titled 'Software for DVR & NVR Systems' and contains a table of software downloads. The table has two columns: the software name and a 'Download' button. The 'SADP Tool for Windows' and 'SADP Tool for Mac' rows are highlighted with a red border.

Software for DVR & NVR Systems	
Desktop Software for Windows	Download
Desktop Software for Mac	Download
Plug-in for Windows	Download
VSPlayer for Windows	Download
SADP Tool for Windows	Download
SADP Tool for Mac	Download

3. Check the box of the camera and then activate the camera by creating a login password.

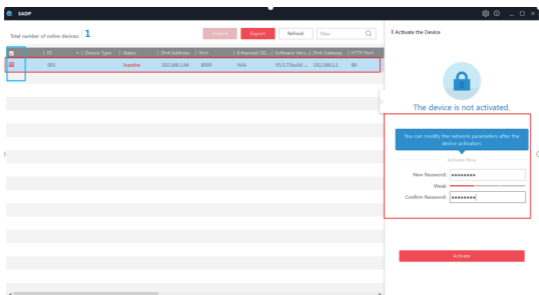

The screenshot shows the SADP software interface. On the left, there is a table of online devices. The first row is selected, and a red box highlights the 'Device Type' column. The table has columns for 'ID', 'Device Type', 'Status', 'IP Address', 'Port', 'Enhanced ID', 'Software Version', and 'HTTP Port'. The first row contains the following data: '001', 'IPC', 'Online', '192.168.1.104', '8000', 'N/A', 'V5.5.716u1d', and '192.168.1.1'. On the right, there is a 'Activate the Device' panel. It features a blue padlock icon and the text 'The device is not activated.' Below this is a blue box with the text 'You can modify the network parameters after the device is activated.' Underneath is a form with three password fields: 'New Password', 'Weak', and 'Confirm Password', each with a red asterisk indicating a weak password. A red 'Activate' button is at the bottom of the panel.

4. Double click the camera's address or you can input the IP address on the IE browser to enter the login page. The default account name is admin and the password is the one you just set up.



5. Download and install the plug-in to view live video and manage the camera. Close the browser when installing the plug-in.

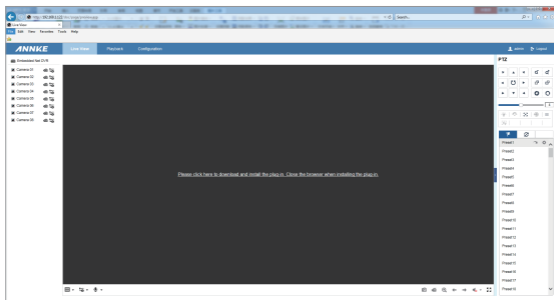

6. Re-open the IE browser and log in the camera. Choose the channel you want to access and set up the camera by clicking Configuration.

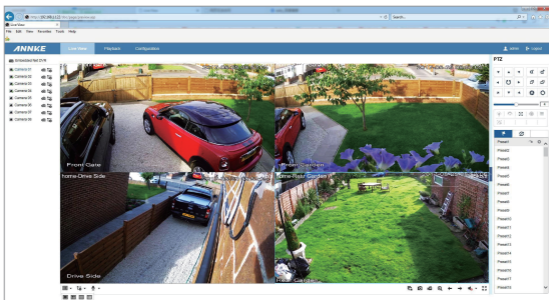



4. Remote Live Stream via Smartphones

You can view the IP camera remotely via your mobile phone with the ANNKE Vision App.

1. Power on the camera with a DC 12 V adapter and connect it to the same router as your computer with a network cable. Make sure the router has connected to the Internet.
2. Download **ANNKE Vision App** from Google Play or Apple Store. Click **Register** to sign up an account with your phone number or email address. Please click **Login** after you have registered the account successfully.

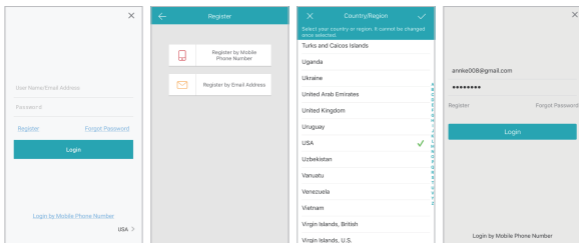
Note: Please select the correct country/region (the same location as your device) when you register an account. It cannot be changed once selected.



3. Select **Add Device** , or click the icon **+** in the upper right corner to add a device. Scan the camera's QR code on the device label. Click **Next** and create a password to activate the device if it has not been activated.

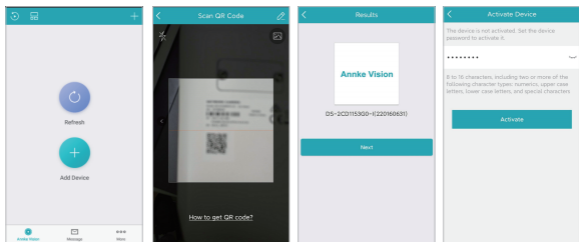

4. Click **Read and Agree ANNKE Vision** terms of service to enable **ANNKE vision** service before continuing to add the device. Create a **verification code** and finish the adding process. After that, the device will be shown in the device list. Click the device name to get live view.

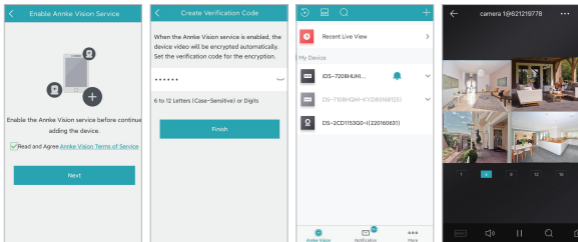

Note: For your security, a serial number can only be added by one account, but an account can be used on multiple mobile phones. You can share your device with others.

5. Operate IP Camera via Computer Software

1. Power on the camera and connect it to the same router as your computer with a network cable.

2. Install the desktop software **Guarding Vision** and search the camera.

You can download **Guarding Vision** from our website:

<https://www.annke.com/pages/download-center>

ANNKE APP

Annke Vision

Annke Sight

Annke Nova

Myannke

Annke Light

Software

Product Manuals

Software for DVR & NVR Systems

Desktop Software for Windows	Download
Desktop Software for Mac	Download
Plug-in for Windows	Download
VSPlayer for Windows	Download
SADP Tool for Windows	Download
SADP Tool for Mac	Download

3. Launch Guarding Vision software. The control panel and live view interface of Guarding Vision are shown below.

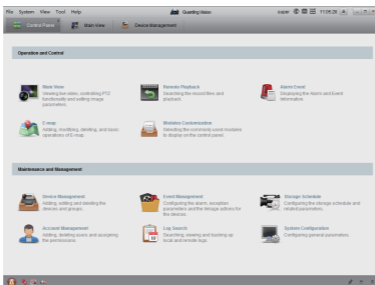

4. Go to **Control Panel-Device Management-Device**. At the bottom of the screen and in the **Online Devices** section, the screen will display all devices on the network. Create a password to activate the device if the device's status is inactive.

5. Click **Add to Client**. Input Nickname, User Name and Password (the password is the same as your activated password instead of the verification code). Click **Add** to add the device to the client software (as shown in the picture below).

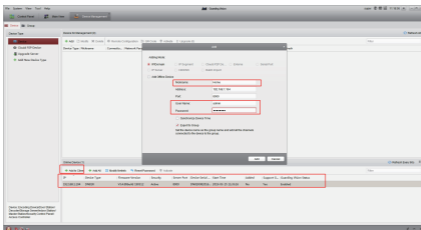

Note: If you want to access the camera remotely via the desktop software Guarding Vision, please choose **Guarding Vision Device** and log in your cloud account to view remote live stream.

6. Go to **Control Panel—Main View**.

If you have added the IP camera, you can get a live view in the screen (as shown in the picture below).

For more information, please press **F1** to get user manual.

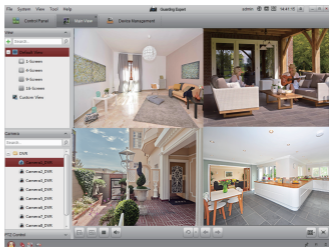

6. View Live Stream with Other Software That Supports RTSP Protocol

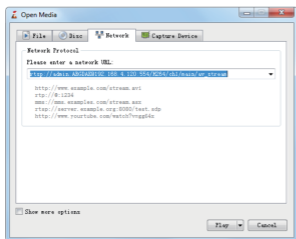

The IP camera supports RTSP protocol. The camera can be accessed via the VLC player, Blue Iris, tinyCam and other software that supports RTSP.

The correct description of RSTP is as below:

`rtsp://[username]: [password]@[ip]: [port]/[codec]/[channel]/[subtype]/av_stream`

User name: admin (default)

Password: The password is the login password used to active your device.

IP: You can get the camera's IP address on the SADP software.

Port: 554

Codec: H264 (H.265)

Channel: ch1 (or the channel which you want to add, for example ch2)

Subtype: main (sub)

Fox example:

`rtsp://admin:qwer1234@192.168.1.64:554/H264/ch1/main/av_stream`

7. Connect IP Cameras to ANNKE DVRs

1. Please confirm that the DVR supports IP cameras. The resolution of the IP camera should not be higher than the resolution that the DVR supports.
For example, the maximum resolution of the DT81DP DVR is 6MP. You can only connect the IP camera with up to 6MP resolution.
2. Make sure the DVR has been activated and connected to the router with a network cable.
3. Connect a DC 12 V power supply to the IP camera for power supply, and use a network cable to connect the router and the IP camera, so that the IP camera and DVR are in the same local area network.
4. Enter the DVR menu: Main Menu -> Camera -> Camera -> IP Camera.
5. Click Refresh to refresh the devices in the local area network. If there is an IP camera, it will be automatically refreshed.

If the IP camera is not activated, the security status will be inactive. You can click **One-touch Active** to activate the IP camera. The security status will become active.
Click the **Add** button, and the Status will display the IP camera status. The playback button will indicate that it has been successfully added.

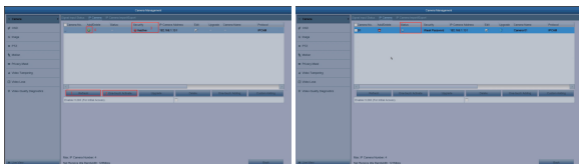

If the IP camera is not activated, the security status will be inactive. You can click **One-touch Active** to activate the IP camera. The security status will become active.
Click the **Add** button, and the Status will display the IP camera status. The playback button will indicate that it has been successfully added.

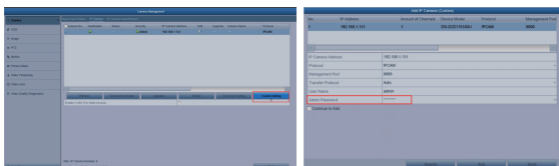

8. Connect IP Cameras to ANNKE NVRs

1. Please confirm that the resolution of the IP camera is not higher than the resolution that the NVR supports.

For example, the maximum resolution that the N48PAW NVR supports is 8MP. You can only connect the IP camera with up to 8MP resolution.

2. Make sure the NVR is activated and can be used normally.

3. Connect the IP camera to the NVR's PoE interface with a network cable.

4. Enter the NVR menu: Main Menu -> Camera Management -> Camera -> IP Camera.

5. Click the **Refresh** button. If the IP camera is not activated or the activation password of the IP camera is the same as the NVR, the NVR will automatically activate the IP camera and add it to the NVR channel. The status display shows that the addition is successful.

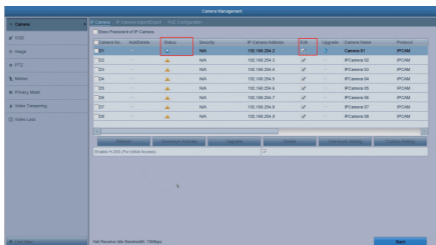

If the activation password of the IP camera is different from the NVR, it is advised to modify the activation password of the IP camera and the NVR through SADP first, and then connect the NVR.

9. Connect the IP Cameras to Other Brands' NVRs via ONVIF Protocol

1. Please confirm that the resolution of the IP camera is not higher than the highest resolution that the NVR supports.

2. Power on the camera and connect it to the same router as your computer with a network cable (instead of connecting the camera to the NVR's POE port).

3. Install the SADP software and then activate the IP camera. Log in the camera via the IE browser.

4. After logging in the camera, please go to Configuration -> Network -> Advance Setting -> Integration Protocol.

Check the **Enable ONVIF** box. Click **Add** to create an **ONVIF account** and password. The ONVIF account and **password** will be used when you add the IP camera to the third-party NVR or DVR.

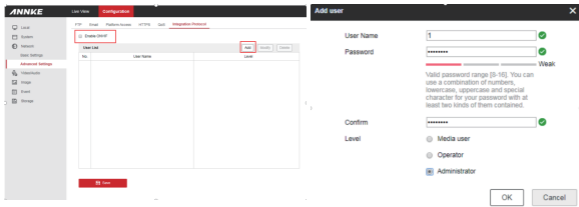

5. Add IP camera to a third-party NVR. Here we take Dahua NVR as an example. Right click the mouse to enter the main menu. Click Setting -> Remote -> Device Search to detect the camera's IP address. Select the camera and click Manual Add.

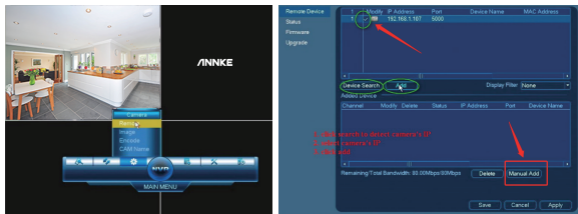

6. Input the correct **ONVIF** user name and password of the IP camera (instead of the login user name and password). The status will be green if the addition is successful. Click **Apply** and you will see the live view.

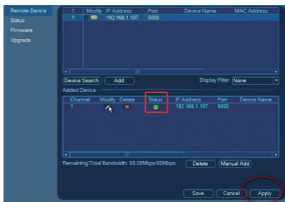

DE

1. Aussehen Beschreibung

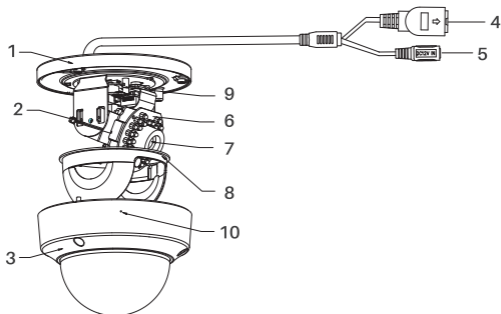

Camera Overview

Nein	Beschreibung	Nein	Beschreibung
1	Befestigungsbasis	6	Infrarot-LED
2	Tilt Adjusting Screw	7	Linse
3	Einstellschraube für Neigung	8	Schwarzer Liner
4	Netzwerkschnittstelle	9	Speicherkartensteckplatz
5	Stromschnittstelle	10	Mic

2. Mit NVR anschließen



Hinweise: Bilder sind nur für Referenz gültig

1. Schließen Sie die Kamera mit dem Ende des Netzwkabel an, wo es einen wasserdichtem Stecker gibt.
2. Schließen Sie die andere Ende des Netzwkabel mit dem PoE Netzwerk-Anschluss vom NVR.



Shenzhen Kean Digital co.,Ltd.

Address: Room 1001, Rujun Building, No.105 Center Road,
Bantian Street, Longgang District, Shenzhen, China.518000

Tech Support Email Address: support@annke.com



Made in China

www.annke.com