

# User Manual

**ANNKE**

**EN:** Please download ANNKE software & user manuals from our download center:

**DE:** Laden Sie bitte die ANNKE-Software und Bedienungsanleitung von unserem Download-Center herunter:

**<https://www.annke.com/pages/download-center>**

## Production Information

Thank you for purchasing our NVRI! This manual is designed for the installation and operation of this product. You can get more information about the features and functions of this product in details. Please read this manual carefully before using. Please contact us if you have any questions.

## Legal Disclaimer

REGARDING TO THE PRODUCT WITH INTERNET ACCESS, THE USE OF PRODUCT SHALL BE WHOLLY AT YOUR OWN RISKS. OUR COMPANY SHALL NOT TAKE ANY RESPONSIBILITIES FOR ABNORMAL OPERATION, PRIVACY LEAKAGE OR OTHER DAMAGES RESULTING FROM CYBER ATTACK, HACKER ATTACK, VIRUS INSPECTION, OR OTHER INTERNET SECURITY RISKS; HOWEVER, OUR COMPANY WILL PROVIDE TIMELY TECHNICAL SUPPORT IF REQUIRED.

SURVEILLANCE LAWS VARY BY JURISDICTION. PLEASE CHECK ALL RELEVANT LAWS IN YOUR JURISDICTION BEFORE USING THIS PRODUCT IN ORDER TO ENSURE THAT YOUR USE CONFORMS THE APPLICABLE LAW. OUR COMPANY SHALL NOT BE LIABLE IN THE EVENT THAT THIS PRODUCT IS USED WITH ILLEGITIMATE PURPOSES.

IN THE EVENT OF ANY CONFLICTS BETWEEN THIS MANUAL AND THE APPLICABLE LAW, THE LATER PREVAILS.

## Regulatory Information

### FCC Conditions

This device complies with part 15 of the FCC Rules. Operation is subject to the following two conditions:

1. This device may not cause harmful interference.
2. This device must accept any interference received, including interference that may cause undesired operation.

### EU Conformity Statement



This product and - if applicable - the supplied accessories too are marked with "CE" and comply therefore with the applicable harmonized European standards listed under the EMC Directive 2004/108/EC, the RoHS Directive 2011/65/EU and Amendment (EU)2015/863.



2012/19/EU (WEEE directive): Products marked with this symbol cannot be disposed of as unsorted municipal waste in the European Union. For proper recycling, return this product to your local supplier upon the purchase of equivalent new equipment, or dispose of it at designated collection points. For more information see: [www.recyclethis.info](http://www.recyclethis.info)



2013/56/EU (battery directive): This product contains a battery that cannot be disposed of as unsorted municipal waste in the European Union. See the product documentation for specific battery information. The battery is marked with this symbol, which may include lettering to indicate cadmium (Cd), lead (Pb), or mercury (Hg). For proper recycling, return the battery to your supplier or to a designated collection point. For more information see: [www.recyclethis.info](http://www.recyclethis.info)

## Safety Instruction

These instructions are intended to ensure that user can use the product correctly to avoid danger or property loss. The precaution measure is divided into [Warnings] and [Cautions].

**Warnings:** Serious injury or death may occur if any of the warnings are neglected.

**Cautions:** Injury or equipment damage may occur if any of the cautions are neglected.

	
Warnings: Follow these safeguards to prevent serious injury or death.	Cautions: Follow these precautions to prevent potential injury or material damage.

### Warnings

- Proper configuration of all passwords and other security settings is the responsibility of the installer and/or end-user.
- In the use of the product, you must be in strict compliance with the electrical safety regulations of the nation and region. Please refer to technical specifications for detailed information.
- Input voltage should meet both the SELV (Safety Extra Low Voltage) and the Limited Power Source with 100 to 240 VAC or 12 VDC according to the IEC60950-1 standard. Please refer to technical specifications for detailed information.
- Do not connect several devices to one power adapter as adapter overload may cause over-heating or a fire hazard.
- Please make sure that the plug is firmly connected to the power socket.
- If smoke, odor or noise rise from the device, turn off the power at once and unplug the power cable, and then please contact the service center.

### Prevention and warning tips:

Only qualified maintenance personnel can perform equipment installation and maintenance. Please make sure to read and understand the complete manual before installation.

- Please install the equipment away from the elderly and children, so as not to cause electrical injury.
- Please ensure the safety of electricity use to avoid fire caused by current overload.
- The NVR unit is designed for indoor use only. Make sure the device is installed in a well-ventilated and dust-free environment. Keep the NVR away from liquids.
- The camera unit supports dustproof and waterproof. Can support outdoor use. Please make sure to fix it firmly. Avoid injury from falling.
- When connecting the cable of the camera unit, please ensure that the connection is waterproof and dustproof. Inadequate links can easily damage the device.
- Before connecting and disconnecting accessories and peripheral devices, turn off the power of the device to avoid damage to the device.
- This device should use the hard disk recommended by the factory. Hard disks of different quality may cause the device to fail to record and fail to start.

# Table of Contents

## EN

1. What's in the Box.....	5
2. Product Introduction.....	6
3. Basic Operations .....	8
4. Remote Access.....	16

## DE

1. Was ist in der Box?.....	20
2. Produkteinführung.....	21
3. Grundlegende Operationen.....	23
4. Fernzugriff.....	30
5. Kontaktieren Sie uns.....	35

## 1. What's in the Box

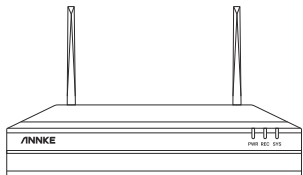

WIFI NVR X1

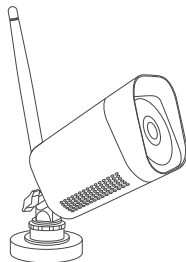

Security Cameras X4

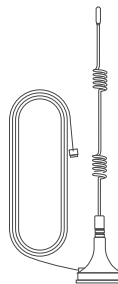

Antenna Extension Cable X1

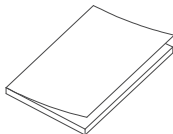

User Manual X1

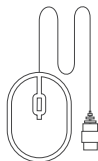

Mouse X1

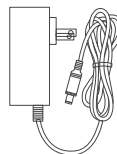

Power Adapter X5



Wall Sticker X4

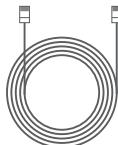

Network Cable X1

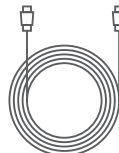

HDMI Cable X1

## 2. Product Introduction

NVR:

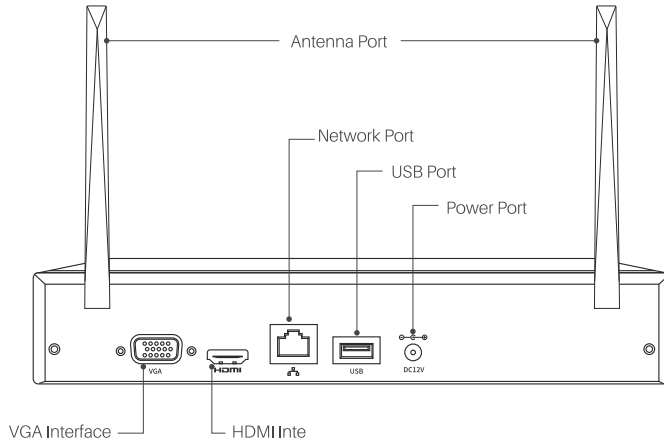

Camera:

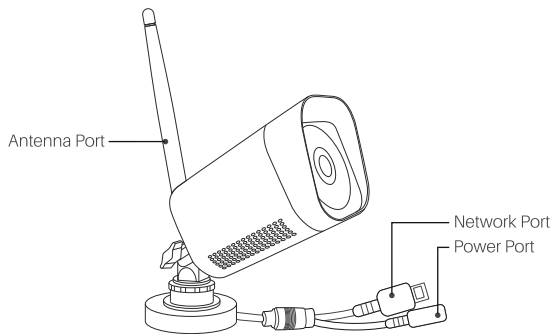

## 2.1 Connection Diagram

Power Adapter  
for cameras

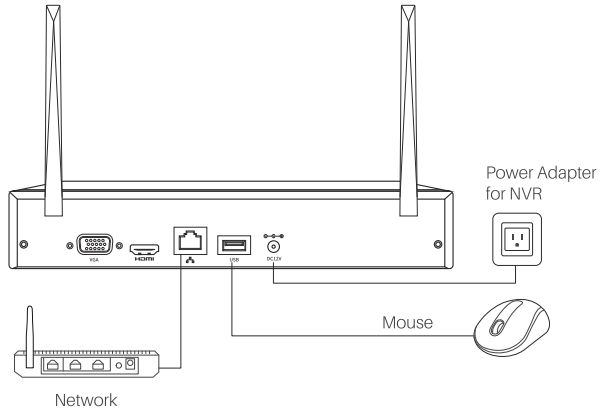
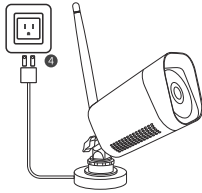

## 2.2 The Camera's Antenna Direction

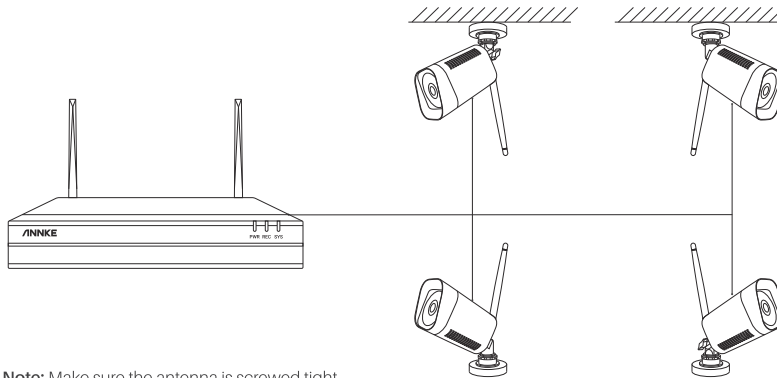

**Note:** Make sure the antenna is screwed tight.



## 3. Basic Operations

### 3.1 Power on the NVR & Security Cameras

Connect the NVR to a monitor or a TV and then connect the NVR and the cameras to an outlet. They will boot automatically.

### 3.2 Log into the System

After the system is launched, click "OK" to log in.  
(The default user name is admin, no password)



### 3.3 Setup Wizard

After the initial login, you will see the setup wizard on the screen, helping you comprehend & set up the system.

#### 3.3.1 General Configuration

Setup [Time Zone], [Date time], [Sync Time], [Date Format], [Language].

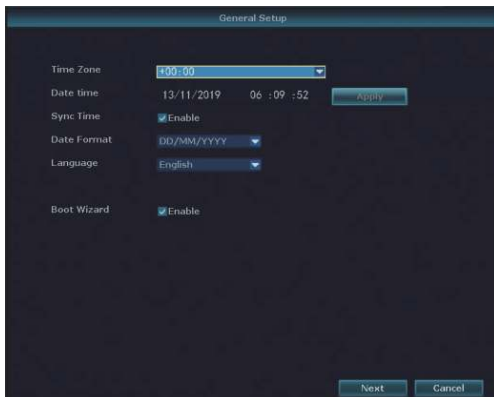

### 3.3.2 Wireless Setup

Please confirm the wireless channel and region.

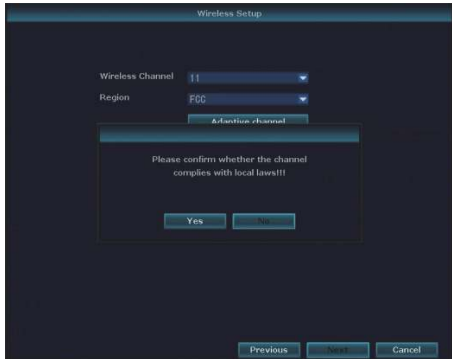
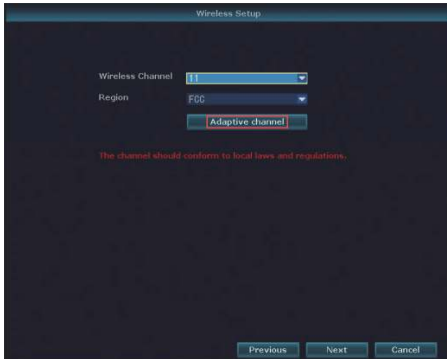

**Note:** The wireless channel and region need to be conform to the local legislation. If the wireless signal is not stable, please click "Adaptive Channel" to improve the signal.

### 3.3.3 Network Configuration

Click "Diagnose" to do a quick check on the NVR's network connection, and then click "Auto Config" to match the network for the NVR.

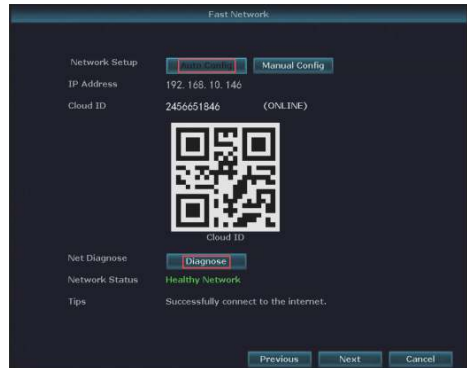

### 3.3.4 HDD Setup

Check the HDD and then click "Format" to format the HDD.

**Note:** Formatting HDD will erase all data contained in the disk. Please be careful when formatting an HDD.

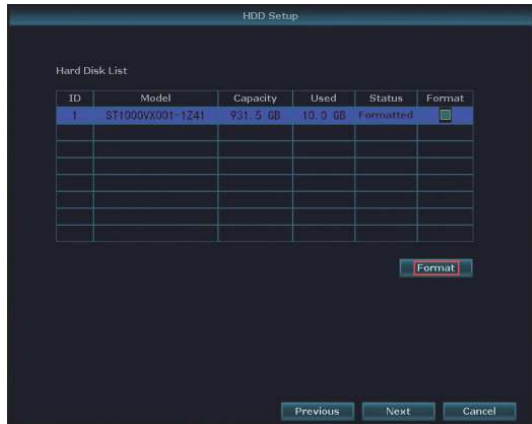

### 3.3.5 Download App

Please download and launch the app. Scan the QR code of the device to add the device.



### 3.4 Change the Password

Please change the password after you have logged into the system.

Right click the mouse. Choose [System Setup] - [System Admin] - [User] to change the password.



**Note:** Please keep your password in mind. If you have forgotten your password, please click the mouse' left and right buttons more than 6 times at a uniform speed.If there is any question, please contact our support team via [support@annke.com](mailto:support@annke.com).

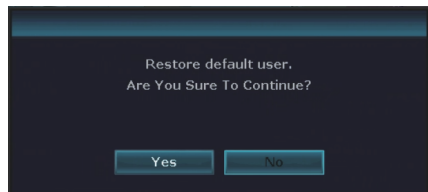

### 3.5 Set up the Video Recording

By default, the system will record 24/7. If you want to change the video recording mode, please re-configure the system. Right click the mouse. Choose [System Setup] - [Record Setup] - [Reset] to select the video recording mode and period.

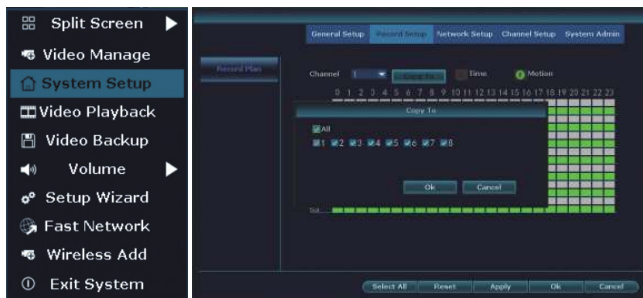

### 3.6 Motion Detection Setup

In default, the motion detection is enabled 24/7 and for all areas. If you want to change the motion detection mode, please re-configure the system.

Right click the mouse. Choose [System Setup] - [Channel Setup] - [Video Detection] to select the sensitivity level, the motion detection period and areas.

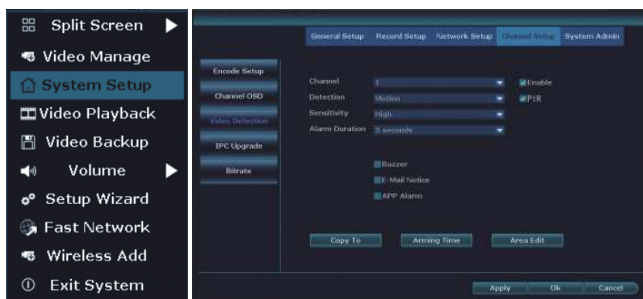

**Note:** Please choose the suitable motion detection areas, period and motion sensitivity level to reduce the false alarms.

### 3.7 Video Playback

Right click the mouse and then choose [Video Playback]. In default, the system will playback today's earliest videos (4 channels).

You can drag the video timeline to play back the videos or speed up the video playback.

Choose the channel & time that you want to play back, and then click "**Search**" to locate the videos in a specific time.













### 3.8 Video Backup

Right click the mouse. Choose [Video Backup] and then select the channel, video recording mode and period. Click "**Search**".

The system will display the video files. Choose the video files that you need and then click "**Backup**".

You will get a prompt to ask you to insert a USB drive. Please insert the USB drive within 60 seconds. The system will back up the video files automatically.

Please remove the USB drive after all the video files have been exported.

-  Split Screen ▶
-  Video Manage
-  System Setup
-  Video Playback
-  **Video Backup**
-  Volume ▶
-  Setup Wizard
-  Fast Network
-  Wireless Add
-  Exit System

Video Backup

Channel  All

1  2  3  4  5  6  7  8

Record Mode:  Time  Motion

Search Title:

USB:

USB storage is not found!  
Please insert USB Storage in one minute.

ID	Cha							Select
1								<input checked="" type="checkbox"/>
2								<input type="checkbox"/>
3								<input type="checkbox"/>
4								<input type="checkbox"/>
5	4	Time	06:10:44	06:30:20	00:19:36	96M		<input type="checkbox"/>
6	1	Time	06:10:44	06:30:20	00:19:36	104M		<input type="checkbox"/>
7	3	Time	06:10:44	06:30:20	00:19:36	93M		<input type="checkbox"/>
8	2	Time	06:10:44	06:30:20	00:19:36	106M		<input type="checkbox"/>

< 1 /5 > avi

Video Backup

Channel  All

1  2  3  4  5  6  7  8

Record Mode:  Time  Motion

Search Title:

USB:

Video is backing up.  
Please Wait...

1%

ID	Cha							Select
1								<input checked="" type="checkbox"/>
2								<input type="checkbox"/>
3								<input type="checkbox"/>
4	4	Time	06:30:26	06:31:58	00:01:32	8M		<input type="checkbox"/>
5	4	Time	06:10:44	06:30:20	00:19:36	96M		<input type="checkbox"/>
6	1	Time	06:10:44	06:30:20	00:19:36	104M		<input type="checkbox"/>
7	3	Time	06:10:44	06:30:20	00:19:36	93M		<input type="checkbox"/>
8	2	Time	06:10:44	06:30:20	00:19:36	106M		<input type="checkbox"/>

< 1 /5 > avi

### 3.9 Email Alert Setup

Right click the mouse. Choose [System Setup] - [Network Setup] - [Email] to set up the email alerts. Please select SMTP provide and encryption type and then input the correct sender, password, SMTP port and the recipient's email address.

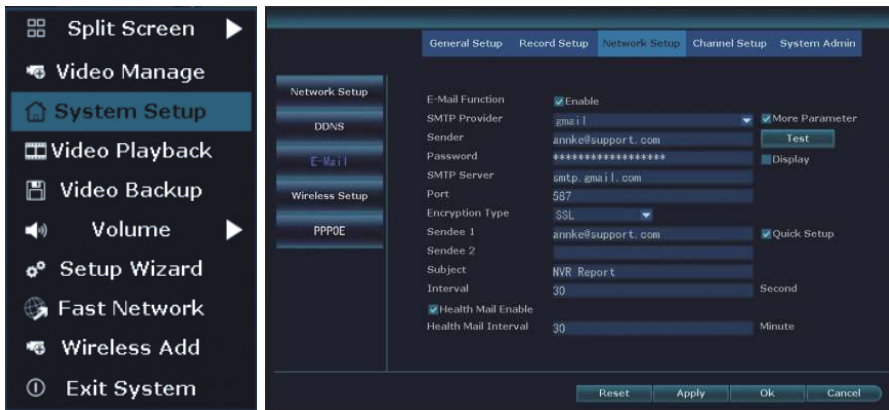

### 3.10 How to Use the Antenna Extension Cable

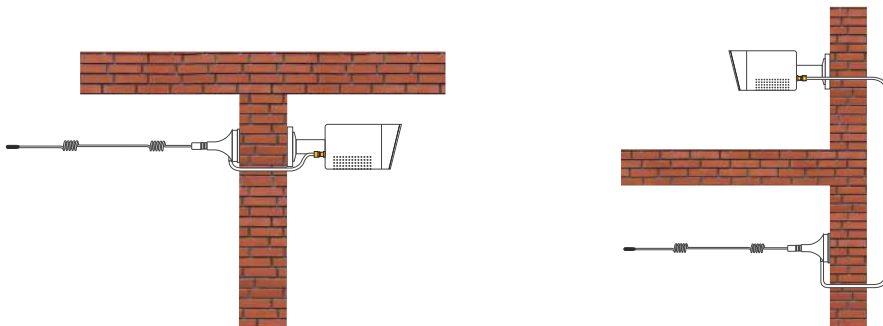



## 4. Remote Access

Before you access the NVR system remotely, make sure the NVR is connected to the Internet. You can refer to 3.3.3 to check the Internet status of the NVR.

### 4.1 Mobile Client Access

**Step 1.** Search "Annke Sight" on App Store or Google Play and then download the app to your smartphone.

**Step 2.** Open the app, click "**Register**". (Picture 1)

**Step 3.** Enter your email address, click "**Confirm**", follow the prompts to complete registration and login. (Picture 2)

**Step 4.** Click the "+" button. (Picture 3)

**Step 5.** Click "**Kit**". (Picture 4)

**Step 6.** Click "⊞"; Scan the ID number on the device. (Picture 5, 6)

**Step 7.** Enter your password and click "**Complete**". (Picture 7)

**Note:** Device has no password by default.

**Step 8.** Now you can preview the device. (Picture 8, 9)

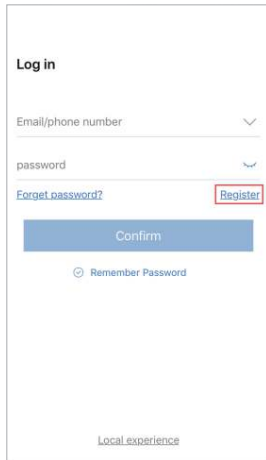

Picture 1

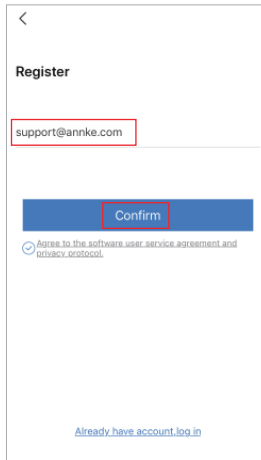

Picture 2



Picture 3



Picture 4

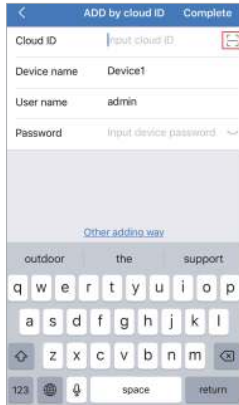

Picture 5

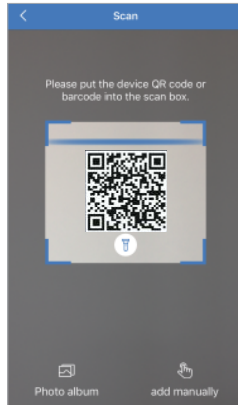

Picture 6

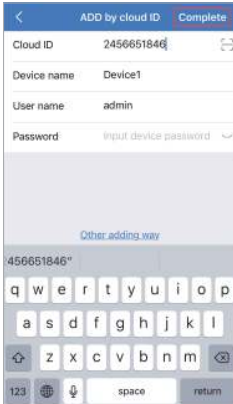

Picture 7



Picture 8



Picture 9

## 4.2 Access the Security System via CMS

**Step 1.** Install "Anne Sight" client on your computer.

**Step 2.** Launch the client and log into your account (**The default user name is admin, no password**). Click "Add" and then enter the ID, username, password, the device type, and the device channel to add the device. Click "Finish".

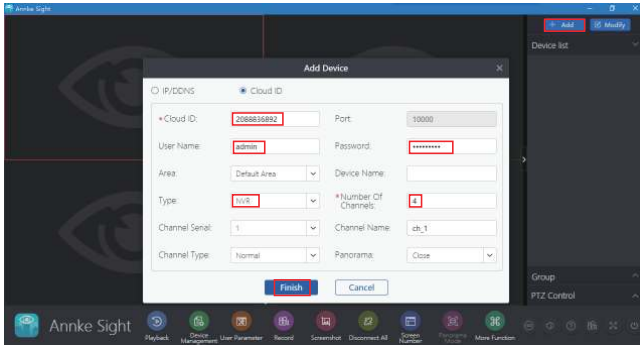

**Step 4.** Move the mouse pointer over the ID number. Right click the mouse and then select "Connect Videos". After several seconds, you can view the remote live streaming.



### 4.3 Access the Security System via a Web Browser

**Step 1.** Launch the IE browser. Enter <http://sight.annke.com> and press the Enter button.

**Step 2.** Enter the ID, username and password to get the live view.

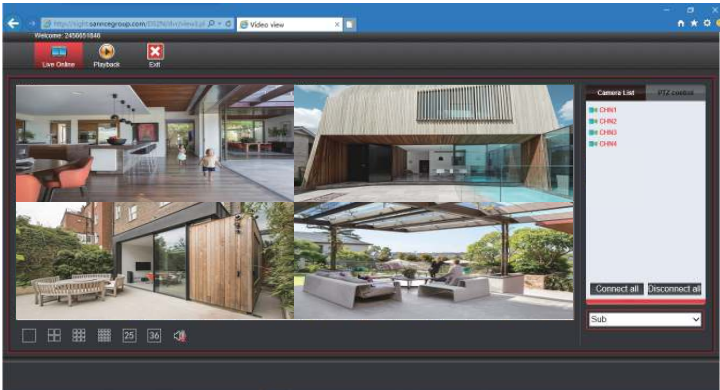
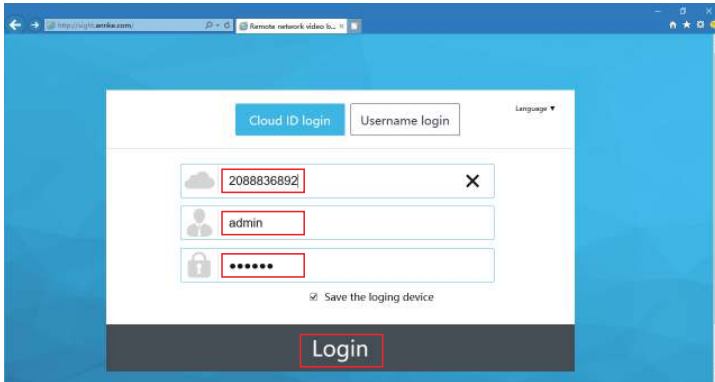

## 1. Was ist in der Box?

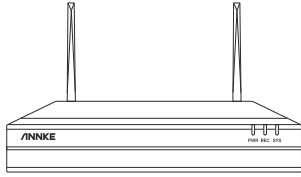

WiFi NVR X1

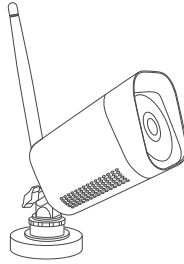

Überwachungskameras X4

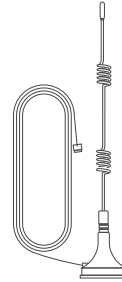

Antennenverlängerungskabel X1

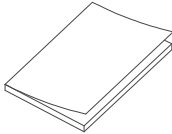

Benutzerhandbuch X1

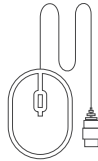

Maus X1

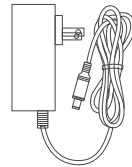

Netzteil X5



Wandaufkleber X4

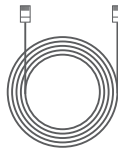

Netzwerkable X1

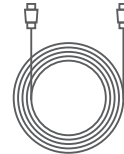

HDMI Kabel X1

## 2. Produkteinführung

NVR:

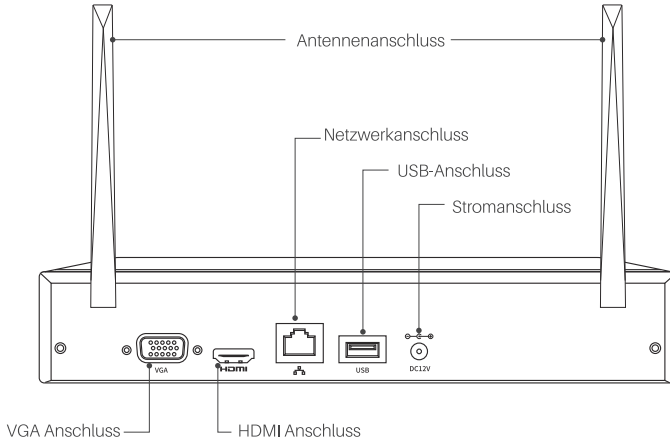

Camera:

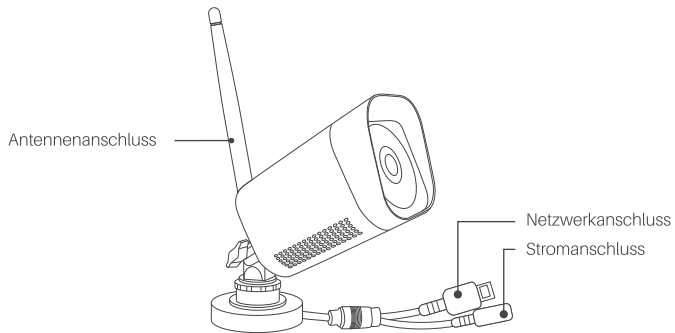

## 2.1 Anschlussplan

Netzteil für Kameras

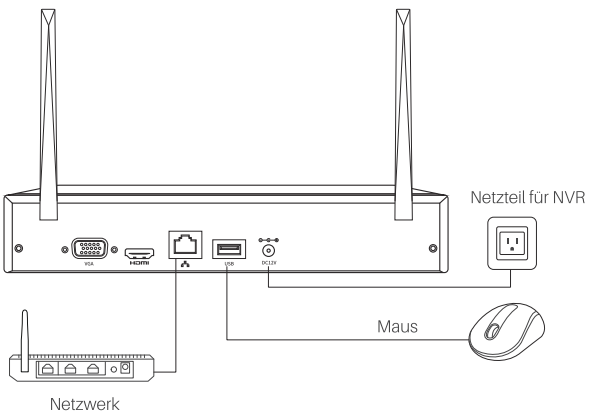
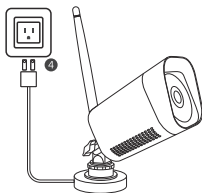

## 2.2 Die Antennenrichtung der Kamer

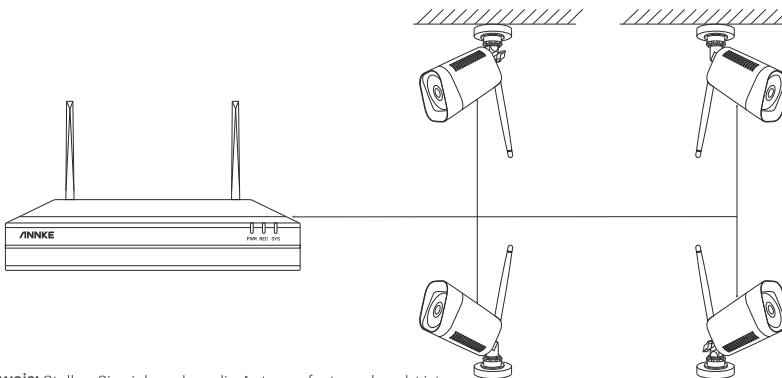

**Hinweis:** Stellen Sie sicher, dass die Antenne festgeschraubt ist.

### 3. Grundlegende Operationen

#### 3.1 Schalten Sie den NVR & die Überwachungskameras ein

Schließen Sie den NVR an einen Monitor oder ein Fernsehgerät an und schließen Sie den NVR und die Kameras an eine Steckdose an. Sie werden automatisch gestartet.

#### 3.2 Melden Sie sich im System an

Klicken Sie nach dem Start des Systems auf "OK", um sich anzumelden.

(Der Standardbenutzername lautet admin, und das Standardkennwort ist leer)

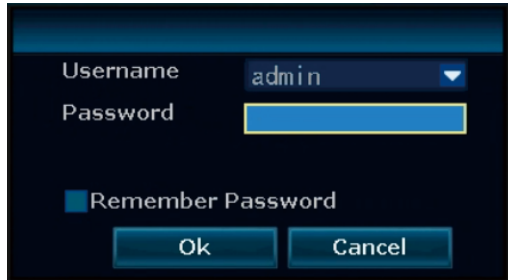

#### 3.3 Setup-Assistent

Nach der erstmaligen Anmeldung wird der Setup-Assistent auf dem Bildschirm angezeigt, der Ihnen hilft, das System zu verstehen und einzurichten.

##### 3.3.1 Allgemeine Konfiguration

Zeitzone einstellen, Datum, Uhrzeitsynchronisation, Datumsformat, Sprache.

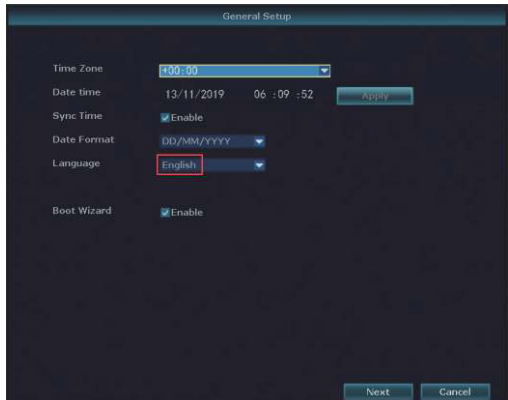



### 3.3.2 Wireless-Setup

Bitte bestätigen Sie den Wireless-Kanal und die Region.

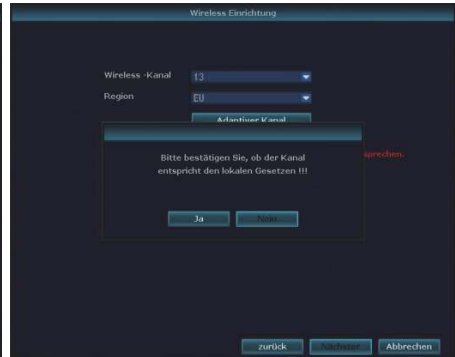
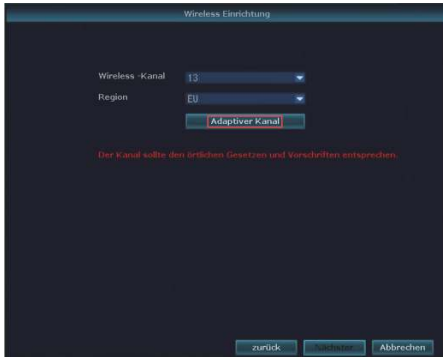

**Hinweis:** Der Wireless-Kanal und die Region müssen den örtlichen Gesetzen entsprechen. Wenn das Wireless-Signal nicht stabil ist, klicken Sie auf **"Adaptiver Kanal"**, um das Signal zu verbessern.

### 3.3.3 Netzwerkkonfiguration

Klicken Sie auf **"diagnostizieren"**, um die Netzwerkverbindung des NVR schnell zu überprüfen, und klicken Sie dann auf **"Auto Config"**, um die Netzwerkverbindung für den NVR anzupassen.

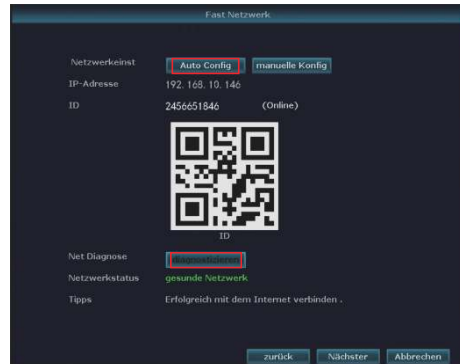

### 3.3.4 Festplatten Setup

Überprüfen Sie die Festplatte und klicken Sie dann auf **"Format"**, um die Festplatte zu formatieren.

**Hinweis:** Beim Formatieren der Festplatte werden alle auf der Festplatte enthaltenen Daten gelöscht. Seien Sie bitte vorsichtig, wenn Sie eine Festplatte formatieren.

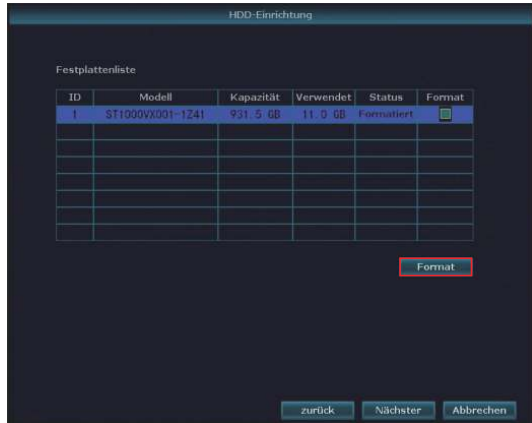

### 3.3.5 App herunterladen

Bitte laden Sie die App herunter und starten Sie sie. Scannen Sie den QR-Code des Geräts, um das Gerät hinzuzufügen.



### 3.4 Ändern Sie das Passwort

Bitte ändern Sie das Passwort, nachdem Sie sich im System angemeldet haben. Klicken Sie mit der rechten Maustaste. Wählen Sie [Menü] - [System Admin] - [Benutzer], um das Passwort zu ändern.

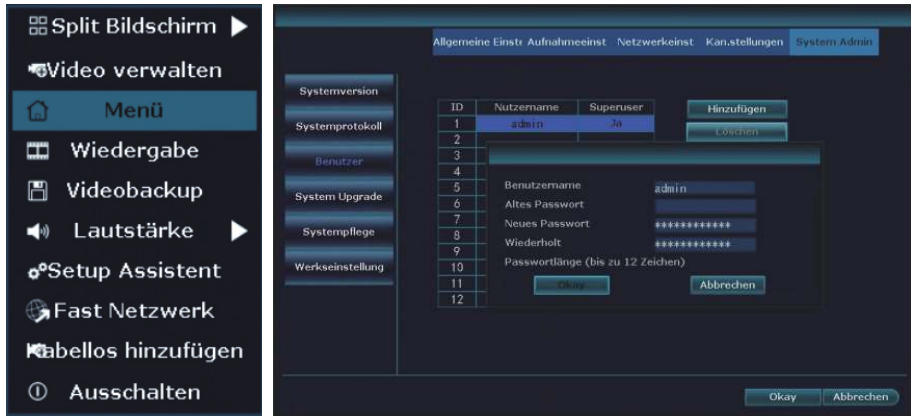

**Hinweis:** Bitte merken Sie sich Ihr Passwort. Wenn Sie Ihr Passwort vergessen haben, klicken Sie mehr als sechs Mal mit einer gleichmäßigen Geschwindigkeit auf die linke und rechte Maustaste. Bei Fragen wenden Sie sich bitte an unser Support-Team unter [support@anne.com](mailto:support@anne.com).

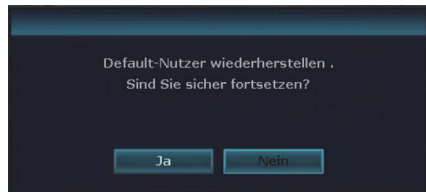

### 3.5 Richten Sie die Videoaufnahme ein

Standardmäßig zeichnet das System rund um die Uhr auf. Wenn Sie den Videoaufzeichnungsmodus ändern möchten, konfigurieren Sie das System neu.

Klicken Sie auf die rechte Maustaste. Wählen Sie **[Menü]** - **[Aufnahmeeinst]** - **[Zurücksetzen]**, um den Videoaufnahmemodus und den Zeitraum auszuwählen.

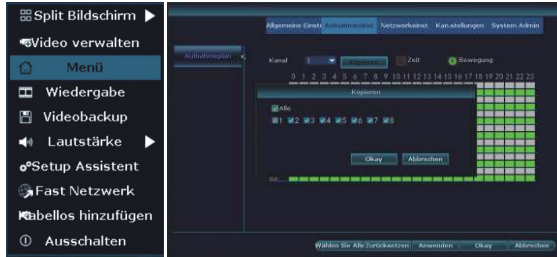

### 3.6 Bewegungserkennungs-Setup

Standardmäßig ist die Bewegungserkennung rund um die Uhr und für alle Bereiche aktiviert. Wenn Sie den Bewegungserkennungsmodus ändern möchten, konfigurieren Sie das System neu.

Klicken Sie auf die rechte Maustaste. Wählen Sie **[Menü]** - **[Kan.stellungen]** - **[Bewegungserkenn]**, um die Empfindlichkeitsstufe, den Bewegungserkennungszeitraum und die Bereiche auszuwählen.

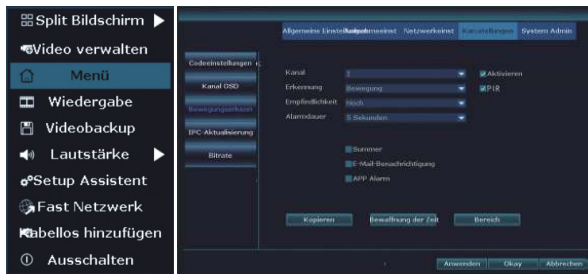

**Hinweis:** Bitte wählen Sie die geeigneten Bereiche für die Bewegungserkennung, den Zeitraum und die Bewegungsempfindlichkeit aus, um Fehlalarme zu reduzieren.

### 3.7 Videowiedergabe

Klicken Sie auf die rechte Maustaste und wählen Sie dann [**Wiedergabe**]. Standardmäßig gibt das System die frühesten Videos von heute wieder (4 Kanäle).

Sie können die Video-Timeline ziehen, um die Videos abzuspielen oder die Videowiedergabe zu beschleunigen.

Wählen Sie den Kanal & die Zeit, die Sie wiedergeben möchten, und klicken Sie dann auf **"Suche"**, um Videos von einer bestimmten Zeit zu suchen.

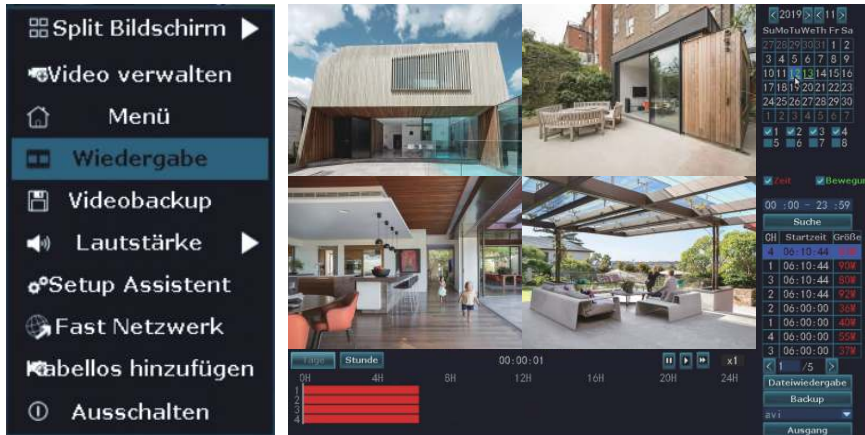

### 3.8 Videosicherung

Klicken Sie auf die rechte Maustaste. Wählen Sie [**Videobackup**] und dann den Kanal, den Videoaufnahmemodus und den Zeitraum. Klicken Sie auf **"Suche"**.

Das System zeigt die Videodateien an. Wählen Sie die gewünschten Videodateien aus und klicken Sie auf **"Backup"**. Sie werden aufgefordert, ein USB-Laufwerk anzuschließen. Bitte stecken Sie den USB-Stick innerhalb von 60 Sekunden ein.

Das System sichert die Videodateien automatisch.

Bitte entfernen Sie das USB-Laufwerk, nachdem alle Videodateien exportiert wurden.

- Split Bildschirm ▶
- Video verwalten
- Menü
- Wiedergabe
- Videobackup**
- Lautstärke ▶
- Setup Assistent
- Fast Netzwerk
- Kabellos hinzufügen
- Ausschalten

Videobackup

Kanal  Alle

1  2  3  4  5  6  7  8

Aufnahme: [Suche Zeit]

Suche Zeit: [Suche Zeit]

USB:

USB-Speicher nicht gefunden  
Bitte geben Sie USB-Speicher in einer Minute

ID	Ka	Zeit	08:00:00	09:00:00	01:00:00	154M	<input type="checkbox"/>
1							<input checked="" type="checkbox"/>
2							<input type="checkbox"/>
3							<input type="checkbox"/>
4							<input type="checkbox"/>
5	4	Zeit	08:00:00	09:00:00	01:00:00	154M	<input type="checkbox"/>
6	3	Zeit	08:00:00	09:00:00	01:00:00	159M	<input type="checkbox"/>
7	2	Zeit	08:00:00	09:00:00	01:00:00	146M	<input type="checkbox"/>
8	1	Zeit	08:00:00	09:00:00	01:00:00	305M	<input type="checkbox"/>

< 1 /7 > avi

Videobackup

Kanal  Alle

1  2  3  4  5  6  7  8

Aufnahme: [Suche Zeit]

Suche Zeit: [Suche Zeit]

USB:

Video sichern.  
Bitte warten...

1%

ID	Ka	Zeit	09:00:00	09:11:14	00:11:14	49M	<input type="checkbox"/>
1							<input checked="" type="checkbox"/>
2							<input type="checkbox"/>
3							<input type="checkbox"/>
4	1	Zeit	09:00:00	09:11:14	00:11:14	49M	<input type="checkbox"/>
5	4	Zeit	08:00:00	09:00:00	01:00:00	154M	<input type="checkbox"/>
6	3	Zeit	08:00:00	09:00:00	01:00:00	159M	<input type="checkbox"/>
7	2	Zeit	08:00:00	09:00:00	01:00:00	146M	<input type="checkbox"/>
8	1	Zeit	08:00:00	09:00:00	01:00:00	305M	<input type="checkbox"/>

< 1 /7 > avi

### 3.9 Email Benachrichtigungen Setup

Klicken Sie auf die rechte Maustaste. Wählen Sie **[Menü] - [Netzwerkeinst] - [E-Mail]**, um die E-Mail-Benachrichtigungen einzurichten.

Bitte wählen Sie den SMTP-Bereitstellung und Verschlüsselungstyp und geben Sie dann den richtigen Absender, das richtige Kennwort, den richtigen SMTP-Port und die E-Mail-Adresse des Empfängers ein.

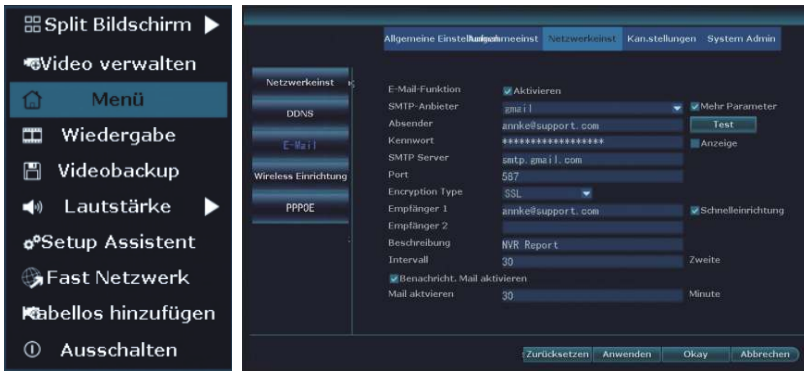

### 3.10 Verwendung des Antennenverlängerungskabels

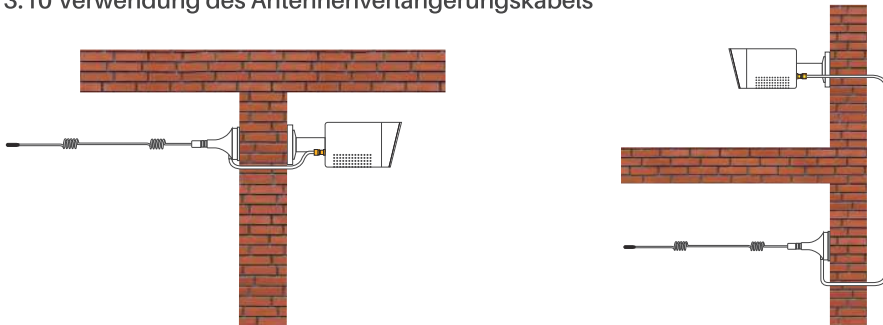

## 4. Fernzugriff

Stellen Sie vor dem Fernzugriff auf das NVR-System sicher, dass der NVR mit dem Internet verbunden ist. Unter 3.3.3 können Sie den Internetstatus des NVR überprüfen.

### 4.1 Mobiler Client-Zugriff

**Schritt 1.** Suchen Sie im App Store oder bei Google Play nach **"Anke Sight"** und laden Sie die App auf Ihr Smartphone herunter.

**Schritt 2.** Öffnen Sie die App und klicken Sie auf **"Registrieren"**. (Bild 1)

**Schritt 3.** Geben Sie Ihre E-Mail-Adresse ein, klicken Sie auf **"Bestätigen"** und folgen Sie den Anweisungen, um die Registrierung und Anmeldung abzuschließen. (Bild 2)

**Schritt 4.** Klicken Sie auf die Schaltfläche "+". (Bild 3)

**Schritt 5.** Klicken Sie auf **"Kit"** (Bild 4).

**Schritt 6.** Klicken Sie auf "☐", und scannen Sie die ID-Nummer auf dem Gerät (Bild 5,6).

**Schritt 7.** Geben Sie Ihr Passwort ein und klicken Sie auf **"komplett"**. (Bild 7)

**Hinweis:** Das Gerät hat standardmäßig kein Kennwort.

**Schritt 8.** Jetzt können Sie eine Vorschau des Geräts anzeigen (Bild 8,9).



Bild 1



Bild 2

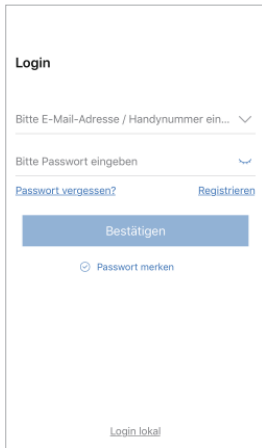

Bild 3



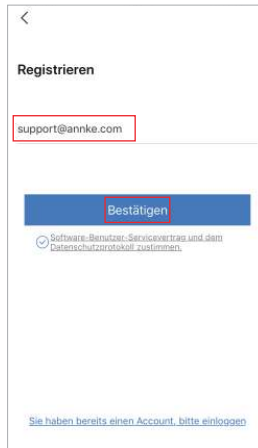

Bild 4

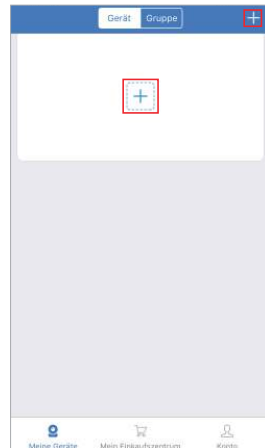

Bild 5



Bild 6

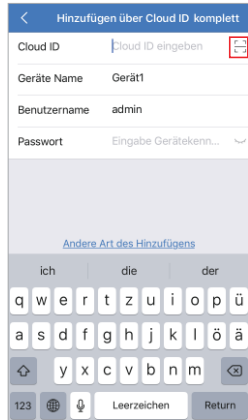

Bild 7

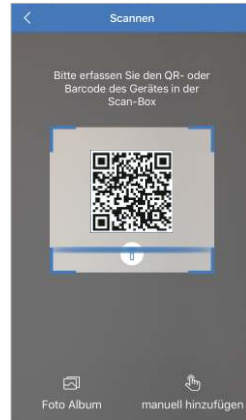

Bild 8

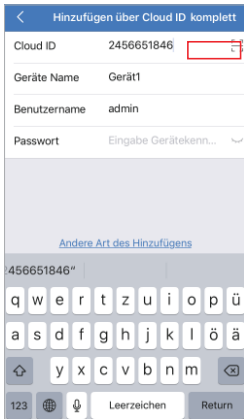

Bild 9

## 4.2 Zugriff auf das Sicherheitssystem über CMS

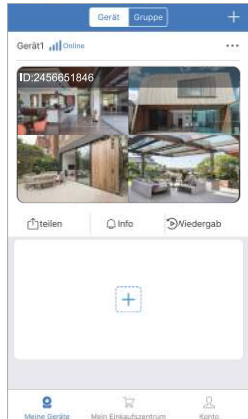
**Schritt 1.** Installieren Sie den Annke Sight-Client auf Ihrem Computer.

**Schritt 2.** Starten Sie den Client und melden Sie sich bei Ihrem Konto an (**Der Standardbenutzername lautet admin, und das Standardkennwort ist leer**). Klicken Sie auf **"Hinzuf."**, und geben Sie die ID, den Benutzernamen, das Kennwort, den Gerätetyp und den Gerätekanal ein, um das Gerät hinzuzufügen. Klicken Sie auf **"Fertig"**.

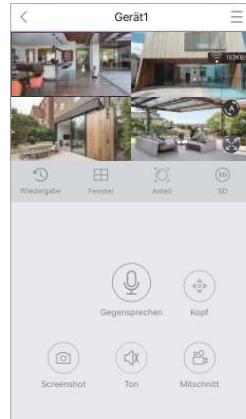
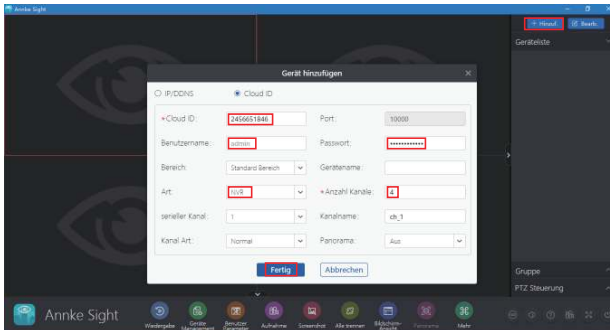

**Schritt 3.** Bewegen Sie den Mauszeiger über die ID-Nummer. Klicken Sie mit der rechten Maustaste und wählen Sie dann **"Videos verbinden"**. Nach einigen Sekunden können Sie das Remote-Live-Streaming anzeigen.

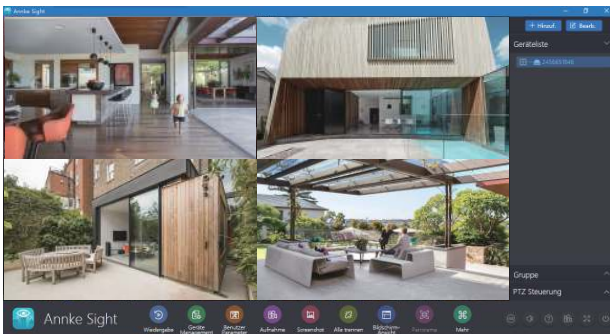

### 4.3 Zugriff auf das Sicherheitssystem über einen Webbrowser

**Schritt 1.** Starten Sie den IE-Browser. Geben Sie `http://sight.annke.com` ein und drücken Sie die Eingabetaste.

**Schritt 2.** Geben Sie die ID, den Benutzernamen und das Passwort ein, um die Live-Ansicht zu erhalten.

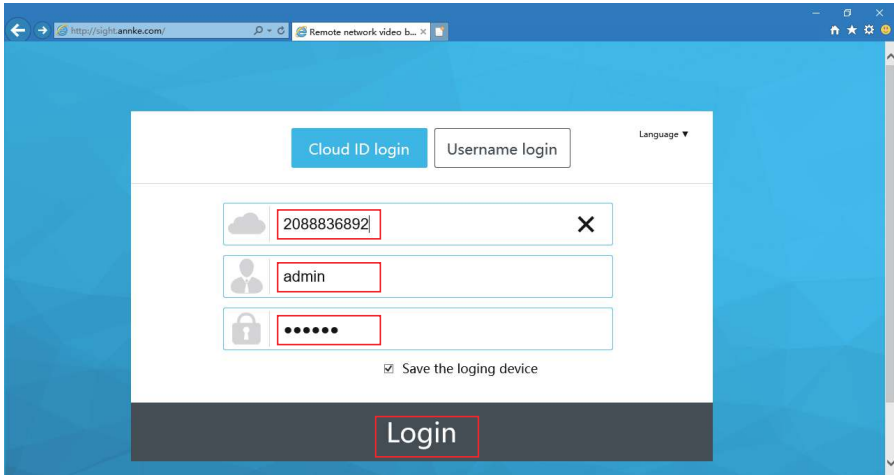

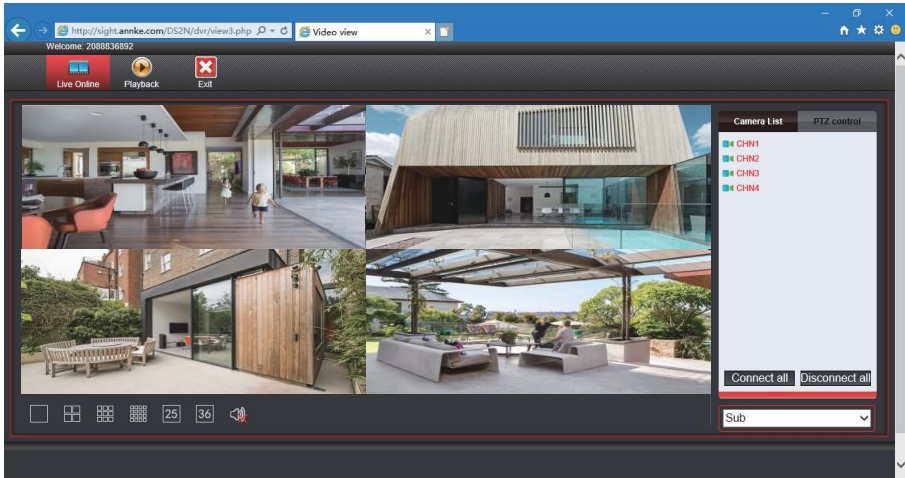

## 5. Kontaktieren Sie uns

Falls Sie Fragen haben, besuchen Sie bitte unser Annke-Hilfezentrum ([help.annke.com](http://help.annke.com)), um Lösungen zur Fehlerbehebung zu erhalten, oder wenden Sie sich per E-Mail an unser Support-Team unter [support@annke.com](mailto:support@annke.com)



Shenzhen Kean Digital co.,Ltd.

Address: Room 1001, Rujun Building, No.105 Center Road,  
Bantian Street, Longgang District, Shenzhen, China.518000

Tech Support Email Address: support@annke.com

FCC ID: 2AKL2-N44WEC



Made in China

[www.annke.com](http://www.annke.com)